

# 6100E

MODEL



## Paperless Graphic Recorder Specification Sheet

- 5.5" Colour TFT touchscreen display
- USB 'plug & play'
- 8MB non-volatile flash memory
- 125ms parallel sampling/1s update
- Compact Flash
- Ethernet TCP/IP
- Web server

The 6100E offers unrivalled input accuracy with a 125ms total sample rate for up to 6 input channels. Input channels are freely configurable to suit your process requirements. Each instrument has an intuitive, touch screen display to enable operators to clearly view process data in varying formats, 8MB of onboard Flash data storage capability, Ethernet communication and a Compact Flash drive. Data is stored in a tamper-resistant binary format that can be used for secure, long term records of your process. The 6100E is truly designed for today's networked world and can be accessed via a Local Area Network, dial-up connection, Intranet or Internet.

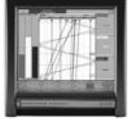
Available features	
	6100E
Display	5.5" 1/4 VGA
Channels	3 standard, 6 optional
Groups	1
Removable media	CF, USB
Communications	Modbus TCP (slave), Ethernet FTP (server & client)
Timers	6
Alarms	4 per channel
Events	3
Custom messages	3
CSV files	Standard
Operator notes	Standard
Bezel	Black
Standard views	Vertical and horizontal trends, vertical and horizontal bar graphs, numeric values
Relays	3 CO optional
Virtual channels	12 optional
Onboard, non-volatile Flash memory	8MB
Environmental protection	IP66
Approvals	CE, CUL
Display update	1s max.
Trend update	1s max.
Web server	Standard
Ethernet (100/100baseT)	Standard
USB Port	1
DHCP	Standard

\* Virtual channels can be configured as maths, totalisers, counters or comms

## Data logging and archiving

The 6100E Series recorder has internal Flash memory for secure data storage. It is also able to accept various removable media types (Compact Flash or USB memory stick). Data stored within the internal memory can be archived to the removable media on demand or at preset intervals. The 6100E will give indication of how long its internal memory and that of the removable media installed will last according to the configuration of the recorder.

All 6000s have Ethernet capability. The 6100E can be configured to archive to the removable media and/or over Ethernet. Archiving files over Ethernet effectively gives a secure, infinite archiving capacity.

Approximate duration for continuous recording of one group of six channels, high compression:

Archive media	Sample rate				
	1s	5s	10s	30s	60s
8Mb Internal Flash (approx. 1 million samples)	5.65 days	28.25 days	56.5 days	1.68 yrs	3.40 yrs
64Mb CF Card or USB memory stick (approx. 8 million samples)	45.3 days	226 days	1.2 yrs	3.7 yrs	7.4 yrs
256Mb CF Card or USB memory stick (approx. 32 million samples)	181 days	2.4 yrs	4.9 yrs	14.8 yrs	20 yrs
1Gb CF Card or USB memory stick (approx. 125 million samples)	1.9 yrs	9.6 yrs	19 yrs	58 yrs	116 yrs
Ethernet (FTP Server)		Infinite			

## Time synchronisation (SNTP)

The 6000 Series support Simple Network Time Protocol which, when enabled, updates the instrument time every 15 minutes from the configured SNTP server. The unit can also act as a Unicast SNTP server on the network, allowing client instruments to synchronise with the 6100E to a resolution of one millisecond.

## Virtual channels

The 6100E virtual channel option provides 12 channels to which can be assigned any of the following math functions: add, subtract, multiply, divide, constant, group, max, channel min, channel max, channel avg., rolling avg. Additionally, any virtual channel can be assigned as a totaliser or counter.

The 12 virtual channels can be made up from a mixed combination of math functions, totalisers and counters.

## Language support

The 6100e supports, as standard, the following languages: English, Spanish, German, French, Italian, Portugese, Japanese and Dutch.

## SPECIFICATION

### Recorder

#### Environmental performance

Temperature limits Operation: 0 to +50°C  
Storage: -20 to 60°C  
Humidity limits Operation: 5% to 80% RH  
Storage: 5% to 90% RH

Protection Bezel and display: IP66  
Sleeve: IP20

Shock: BS EN61010  
Vibration (10 to 150Hz): BSEN60873, Section 9,18  
Altitude: <2000 metres

#### Approvals

#### Electromagnetic compatibility CE, cUL (EMC)

UL file number: e57766  
Emissions and immunity: BS EN61326

#### Electrical safety

(BS EN61010): Installation cat. II; Pollution degree 2

#### INSTALLATION CATEGORY II

The rate impulse voltage for equipment on nominal 230V mains is 2500V.

#### POLLUTION DEGREE 2

Normally, only non-conductive pollution occurs. Occasionally, however, a temporary conductivity caused by condensation shall be expected

#### Physical

Panel mounting: DIN43700  
Panel mounting angle: ±45°  
6100E Bezel size: 144 x 144mm  
Panel cutout dimensions: 138 x 138mm (both -0/+1mm)  
Depth behind bezel rear face: 246.5mm (284 LTC)  
Weight: 3kg max. (5kg if fitted in portable case)

#### Operator interface

Type: Colour TFT LCD with cold cathode backlight, fitted with resistive, analogue, Touch-Panel

#### Size and resolution

Model 6100E: 1/4VGA (320 x 240 pixels) 5.5"

#### Power requirements

Supply voltage Standard: 85 to 265V ac; 47 to 63Hz or 110 to 370V dc  
Low voltage option: 20 to 42V RMS; 45 to 400Hz or 20 to 54V dc

Power (Max): 60VA (Inrush current 36A)  
Fuse type: None

#### Interrupt protection

Standard: Holdup >200msec, at 240V ac, with full load

Low voltage option: 20msec at 20V dc or RMS, with full load

#### Back-up battery

Type: Poly-carbonmonofluoride/lithium (BR2330) Part No. PA261095

Support time (RTC): 1 year min. with recorder unpowered  
Replacement period: 3 years

Stored data: Time; date; values for totalisers, counters and timers; batch data; Fvalue, Rolling average, Stopwatch etc.

#### Ethernet communications

Type: 10/100baseT Ethernet. (IEEE802.3)

Protocols: TCP/IP, FTP, DHCP, BOOTP, SNTP, MODBUS, ICMP

Cable Type: CAT5  
Maximum length: 100 metres  
Termination: RJ45

## Input board

### General

Input types: dc Volts, dc millivolts, dc milliamps (with shunt), Thermocouple, 2/3-wire RTD  
Contact closure (not Channel 1) >60 ms  
Input type mix: Freely configurable.  
Maximum number of inputs: 6 per board  
A/D conversion method: >16 bits, 2nd order delta sigma  
Input ranges: See Table1 and Table 2 below.  
Termination: Edge connector / terminal block  
Noise rejection (48 to 62Hz): Common mode: >140dB (channel to channel and channel to ground).  
Series mode: >60dB.

Maximum common mode voltage: 250 Volts continuous  
 Maximum series mode voltage: 45mV at lowest range; 23.74 Volts peak at highest range  
 Isolation  
 Channel to channel: 300V RMS or dc (double insulation)  
 Channel to common electronics: 300V RMS or dc (double insulation)  
 Channel to ground: 300V RMS or dc (basic insulation)  
 Dielectric strength (BS EN61010) (1 minute type tests)  
 Channel to channel: 2500V ac  
 Channel to ground: 1500V ac  
 Insulation resistance: >10MΩ at 500 V dc  
 Input impedance: 38mV, 150 mV, 1 V ranges: >10MΩ; 20V range: 65.3kΩ  
 Over voltage protection: 50 Volts peak (150V with attenuator)  
 Open circuit detection: ± 57nA max.  
 Recognition time: 500msec  
 Minimum break resistance: 10MΩ

**Update/archive rates**  
 Input/Relay-output sample rate: 8Hz  
 Trend update: 1Hz maximum  
 Archive sample-value: Latest value at archive time  
 Display value: Latest value at display update time (8Hz)

**DC Input ranges**  
 Shunt: Externally mounted resistor modules  
 Additional error due to shunt: 0.1% of input  
 Additional error due to attenuator: 0.2% of input  
 Performance: See Table 1

**Thermocouple data**  
 Temperature scale: ITS 90  
 Bias current: 0.05 nA  
 Cold junction types: Off, internal, external, remote  
 CJ error: 1°C max with inst. at 25°C  
 CJ rejection ratio: 50:1 minimum

Low Range	High Range	Resolution	Typical error (instrument at 20°C) Range	Maximum error (instrument at 20°C) Range	Worst case temp Performance Input per °C
-38mV	38mV	1.4µV	0.013% I/P + 0.031%	0.030% I/P + 0.052%	25ppm
-150mV	150mV	5.5µV	0.013% I/P + 0.028%	0.029% I/P + 0.039%	25ppm
-1V	1V	37µV	0.013% I/P + 0.024%	0.029% I/P + 0.029%	25ppm
-20V	20V	720µV	0.075% I/P + 0.027%	0.393% I/P + 0.033%	388ppm

Table 1 Voltage ranges - accuracy and resolution

Low Range	High Range	Resolution	Typical error (instrument at 20°C) Range	Maximum error (instrument at 20°C) Range	Worst case temp Performance Input per °C
0Ω	150Ω	5mΩ	0.027% I/P + 0.034%	0.037% I/P + 0.077%	30ppm
0Ω	600Ω	22mΩ	0.027% I/P + 0.035%	0.037% I/P + 0.057%	30ppm
0Ω	5KΩ	148mΩ	0.030% I/P + 0.034%	0.040% I/P + 0.041%	30ppm

Table 2 Resistance ranges - accuracy and resolution

T/C Type	Overall range (°C)	Standard	Max linearisation error
B	0 to +1820	IEC 584.1	0 to 400°C = 1.7°C 400 to 1820°C = 0.03°C
C	0 to +2300	Hoskins	0.12°C
D	0 to +2495	Hoskins	0.08°C
E	-270 to +1000	IEC 584.1	0.03°C
G2	0 to +2315	Hoskins	0.07°C
J	-210 to +1200	IEC 584.1	0.02°C
K	-270 to +1372	IEC 584.1	0.04°C
L	-200 to +900	DIN43710:1985 (To IPTS68)	0.02°C
N	-270 to +1300	IEC 584.1	0.04°C
R	-50 to +1768	IEC 584.1	0.04°C
S	-50 to +1768	IEC 584.1	0.04°C
T	-270 to +400	IEC 584.1	0.02°C
U	-200 to +600	DIN43710:1985	0.08°C
NiMo/NiCo	-50 to +1410	ASTM E1751-95	0.06°C
Ni/NiMo	0 to +1406	Ipsen	0.14°C
Platinel	0 to +1370	Engelhard	0.02°C
Pt20%Rh/ Pt40%Rh	0 to +1888	ASTM E1751-95	0.07°C

Table 3 Thermocouple types and ranges

Upscale/downscale drive: High, low or none selectable for each thermocouple channel  
 Additional error: 0.01°C (typ.) if high or low selected  
 Types and ranges: See Table 3

### Resistance inputs

Ranges (including lead resistance): 0 to 150Ω, 0 to 600Ω, 0 to 6kΩ  
 Influence of lead resistance  
 Error: Negligible  
 Mismatch: 1Ω/Ω  
 Temperature scale: ITS90  
 Accuracy and resolution: See Table 2  
 RTD types and ranges: See Table 4

RTD Type	Overall range (°C)	Standard	Max linearisation error
Cu10	-20 to +400	General Electric Co.	0.02 °C
Cu53	-70 to ± 200	RC21-4-1966	<0.01°C
JPT100	-220 to +630	JIS C1604:1989	0.01 °C
Ni100	-60 to +250	DIN43760:1987	0.01 °C
Ni120	-50 to +170	DIN43760:1987	0.01 °C
Pt100	-200 to +850	IEC 751	0.01 °C
Pt100A	-200 to +600	Eurotherm Recorders SA	0.09 °C
Pt1000	-200 to +850	IEC 751	0.01 °C

Table 4 RTD types and ranges

### Transmitter PSU

Number of outputs: Three, isolated  
 Output voltage: 25V nominal  
 Maximum current: 20mA per output  
 Isolation (dc to 65Hz BS61010): Installation category II; Pollution degree 2  
 Channel to channel: 100V RMS or DC (double insulation)  
 Channel to ground: 100V RMS or dc (basic insulation)  
 Fuse (20mm Type T)  
 Supply voltage = 110/120V ac: 100mA  
 Supply voltage = 220/240V ac: 63mA

### Relay output board

**General**  
 Maximum number of relay boards: 1  
 Number of relays per board: 3 per C/O  
 Estimated mechanical life: 30,000,000 operations  
 Update rate: See 'Update rates' in 'Recorder Specification' above

### AC load ratings

Derating  
 The figures give below are for resistive loads. for reactive or inductive loads, de-rate in accordance with Graph 1, in which:

- F1 = Actually measured results on representative samples
- F2 = Typical values according to experience
- Contact life = Resistive contact life x reduction factor

Maximum switching power: 500VA  
 Maximum contact voltage: 250V providing this does not cause the maximum switching power (above) to be exceeded  
 Maximum contact current: 2 Amps providing this does not cause the maximum switching power (above) to be exceeded

### DC load ratings

Maximum switching power: See Graph 2 for operating volt/amp envelope  
 Maximum contact voltage/current: See Graph 2 for examples

### Safety isolation

Isolation (dc to 65Hz; BS EN61010): Installation category II; Pollution degree 2  
 Relay to relay: 300V RMS or dc (double insulation)  
 Relay to ground: 300V RMS or dc (basic insulation)

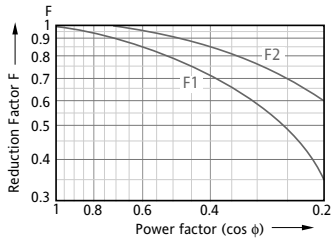

Graph 1  
Derating curves for ac loads

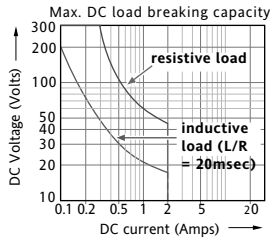

Graph 2  
DC load switching curves

### Input board wiring

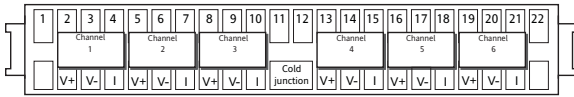

### Relay board wiring

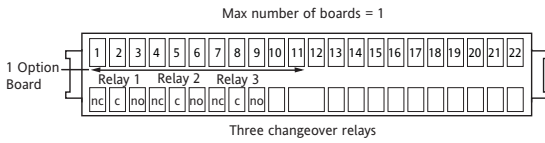

### Isolated transmitter power supply wiring

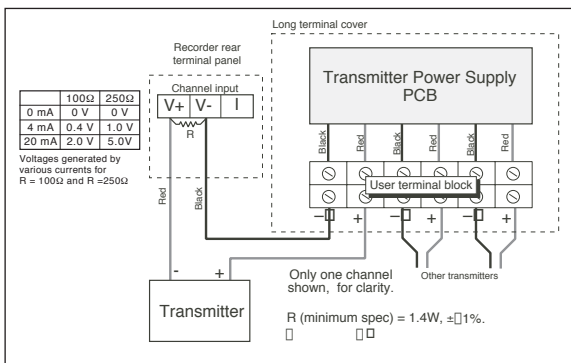

### Mechanical installation

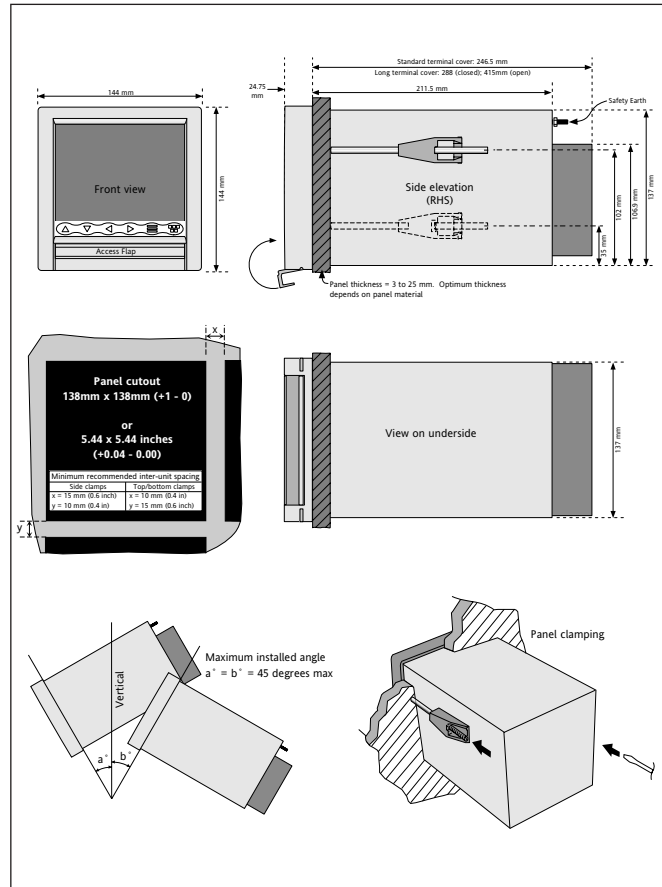

### Rear terminal connections

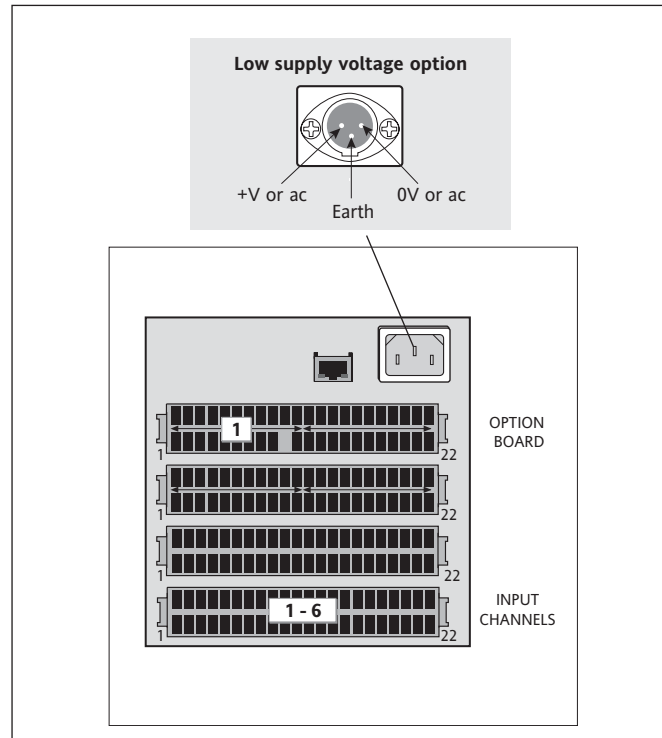

## Input board signal wiring

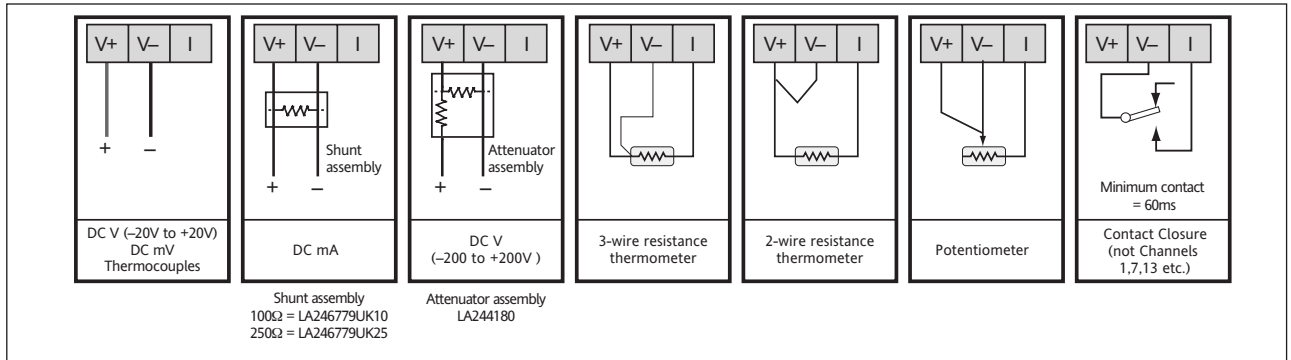

## Ordering code

1	2	3	4	5	6	7	8	9	10	11	12
---	---	---	---	---	---	---	---	---	----	----	----

<b>1</b>	<b>Number of channels</b>	
	3 Input channels	.U03
	6 Input Channels	.U06
<b>2</b>	<b>Power supply</b>	
	90-264V ac 110-370V dc 45-65Hz	.VH
	20-42V ac RMS, 20-54V dc	.VH
<b>3</b>	<b>24V Isolated transmitter power supply</b>	
	None	.NOITPS
	110-120V 3 channel TPS	.115TPS
	220-240V 3 channel TPS	.230TPS
<b>4</b>	<b>Memory card size</b>	
	None	.NOMC
	128 Mbyte card (CF)	.128M
	256 Mbyte card (CF)	.256M
	512 Mbyte card (CF)	.512M
	1 Gbyte card (CF)	.001G
<b>5</b>	<b>USB Memory stick size</b>	
	None	.NOMS
	128 Mbyte USB memory stick	.128MMS
	256 Mbyte USB memory stick	.256MMS
	512 Mbyte USB memory stick	.512MMS
	1 Gbyte USB memory stick	.001GMS
<b>6</b>	<b>Calibration certificates</b>	
	None	.NICAL
	Standard calibration certificate (all channels at 0-1V dc)	.STCAL
	Custom calibration of each channel as specified on purchase order	.CMCAL
<b>7</b>	<b>Changeover relays</b>	
	None	.00
	3 changeover relays (1 option board)	.03
<b>8</b>	<b>QTY of shunts</b>	
	Qty of shunts	.00
<b>9</b>	<b>Shunt value</b>	
	No shunts	.NOS
	100 ohm shunts	.100
	250 ohm shunts	.250
<b>10</b>	<b>Qty of 100:1 attenuators</b>	
	Quantity of attenuators	.00
<b>11</b>	<b>Warranty</b>	
	Standard warranty	.XXXXX
	5 Year warranty	.1WL005
<b>12</b>	<b>Maths, Totalisers and counters</b>	
	None	.MTC00
	12 virtual channels	.MTC12

### Standard accessories:

- Installation and safety data sheet
  - Panel mounting clamps
  - Panel seal
  - User manual
- Via internet download from [www.eurotherm.com/6100E](http://www.eurotherm.com/6100E)

### Optional accessories:

- Via internet download from <http://my.eurotherm.co.uk>
- 6000 Tools including Review Lite (history viewing software and C-Edit (off line configuration software).
  - Review Full
- All the functionality of Review Lite plus ability to run as a service spreadsheet mode and auto archive the database.

## Eurotherm: International sales and service

Understanding and providing local support is a key part of Eurotherm's business. Complementing worldwide Eurotherm offices are a whole range of partners and a comprehensive technical support team... to ensure you get a service you will want to go back to.

**AUSTRALIA** *Sydney*  
Eurotherm Pty. Ltd.  
T (+61 2) 9838 0099  
F (+61 2) 9838 9288  
E [info.au@eurotherm.com](mailto:info.au@eurotherm.com)

**AUSTRIA** *Vienna*  
Eurotherm GmbH  
T (+43 1) 7987601  
F (+43 1) 7987605  
E [info.at@eurotherm.com](mailto:info.at@eurotherm.com)

**BELGIUM & LUXEMBOURG** *Moha*  
Eurotherm S.A./N.V.  
T (+32) 85 274080  
F (+32) 85 274081  
E [info.be@eurotherm.com](mailto:info.be@eurotherm.com)

**BRAZIL** *Campinas-SP*  
Eurotherm Ltda.  
T (+5519) 3707 5333  
F (+5519) 3707 5345  
E [info.br@eurotherm.com](mailto:info.br@eurotherm.com)

**DENMARK** *Copenhagen*  
Eurotherm Danmark AS  
T (+45 70) 234670  
F (+45 70) 234660  
E [info.dk@eurotherm.com](mailto:info.dk@eurotherm.com)

**FINLAND** *Abo*  
Eurotherm Finland  
T (+358) 22506030  
F (+358) 22503201  
E [info.fi@eurotherm.com](mailto:info.fi@eurotherm.com)

**FRANCE** *Lyon*  
Eurotherm Automation SA  
T (+33 478) 664500  
F (+33 478) 352490  
E [info.fr@eurotherm.com](mailto:info.fr@eurotherm.com)

**GERMANY** *Limburg*  
Eurotherm Deutschland GmbH  
T (+49 6431) 2980  
F (+49 6431) 298119  
E [info.de@eurotherm.com](mailto:info.de@eurotherm.com)

**HONG KONG & CHINA**  
Eurotherm Limited *North Point*  
T (+85 2) 28733826  
F (+85 2) 28700148  
E [info.hk@eurotherm.com](mailto:info.hk@eurotherm.com)

*Guangzhou Office*  
T (+86 20) 8755 5099  
F (+86 20) 8755 5831  
E [info.cn@eurotherm.com](mailto:info.cn@eurotherm.com)

*Beijing Office*  
T (+86 10) 6567 8506  
F (+86 10) 6567 8509  
E [info.cn@eurotherm.com](mailto:info.cn@eurotherm.com)

*Shanghai Office*  
T (+86 21) 6145 1188  
F (+86 21) 6145 1187  
E [info.cn@eurotherm.com](mailto:info.cn@eurotherm.com)

**INDIA** *Chennai*  
Eurotherm India Limited  
T (+91 44) 24961129  
F (+91 44) 24961831  
E [info.in@eurotherm.com](mailto:info.in@eurotherm.com)

**IRELAND** *Dublin*  
Eurotherm Ireland Limited  
T (+353 1) 4691800  
F (+353 1) 4691300  
E [info.ie@eurotherm.com](mailto:info.ie@eurotherm.com)

**ITALY** *Como*  
Eurotherm S.r.l.  
T (+39 31) 975111  
F (+39 31) 977512  
E [info.it@eurotherm.com](mailto:info.it@eurotherm.com)

**KOREA** *Seoul*  
Eurotherm Korea Limited  
T (+82 31) 2738507  
F (+82 31) 2738508  
E [info.kr@eurotherm.com](mailto:info.kr@eurotherm.com)

**NETHERLANDS** *Alphen a/d Rijn*  
Eurotherm B.V.  
T (+31 172) 411752  
F (+31 172) 417260  
E [info.nl@eurotherm.com](mailto:info.nl@eurotherm.com)

**NORWAY** *Oslo*  
Eurotherm A/S  
T (+47 67) 592170  
F (+47 67) 118301  
E [info.no@eurotherm.com](mailto:info.no@eurotherm.com)

**POLAND** *Katowice*  
Invensys Eurotherm Sp z o.o.  
T (+48 32) 2185100  
F (+48 32) 2177171  
E [info.pl@eurotherm.com](mailto:info.pl@eurotherm.com)

**SPAIN** *Madrid*  
Eurotherm España SA  
T (+34 91) 6616001  
F (+34 91) 6619093  
E [info.es@eurotherm.com](mailto:info.es@eurotherm.com)

**SWEDEN** *Malmö*  
Eurotherm AB  
T (+46 40) 384500  
F (+46 40) 384545  
E [info.se@eurotherm.com](mailto:info.se@eurotherm.com)

**SWITZERLAND** *Wollerau*  
Eurotherm Produkte (Schweiz) AG  
T (+41 44) 7871040  
F (+41 44) 7871044  
E [info.ch@eurotherm.com](mailto:info.ch@eurotherm.com)

**UNITED KINGDOM** *Worthing*  
Eurotherm Limited  
T (+44 1903) 268500  
F (+44 1903) 265982  
E [info.uk@eurotherm.com](mailto:info.uk@eurotherm.com)  
[www.eurotherm.co.uk](http://www.eurotherm.co.uk)

**U.S.A.** *Leesburg VA*  
Eurotherm Inc.  
T (+1 703) 443 0000  
F (+1 703) 669 1300  
E [info.us@eurotherm.com](mailto:info.us@eurotherm.com)  
[www.eurotherm.com](http://www.eurotherm.com)

ED53

© Copyright Eurotherm Limited 2007

Invensys, Eurotherm, the Eurotherm logo, Chessell, EurothermSuite, Mini8, Eycon, Eyris and Wonderware are trademarks of Invensys plc, its subsidiaries and affiliates. All other brands may be trademarks of their respective owners.

All rights are strictly reserved. No part of this document may be reproduced, modified, or transmitted in any form by any means, nor may it be stored in a retrieval system other than for the purpose to act as an aid in operating the equipment to which the document relates, without the prior written permission of Eurotherm limited.

Eurotherm Limited pursues a policy of continuous development and product improvement. The specifications in this document may therefore be changed without notice. The information in this document is given in good faith, but is intended for guidance only.

Eurotherm Limited will accept no responsibility for any losses arising from errors in this document.