

 LaMotte

pH 5 PLUS

pH/°C



CE

PREFACE

This manual serves to explain the use of the pH 5 PLUS meter.

This manual functions in two ways: first as a step by step guide to operating the meter; second, as a handy reference guide.

This manual is written to cover as many anticipated applications of the meter as possible. If there are questions about the use of this meter contact the LaMotte Tech Service Department.

LaMotte Company will not accept any responsibility for damage or malfunction to the meter caused by improper use of the instrument.

The information presented in this manual is subject to change without notice as improvements are made, and does not represent a commitment on the part of LaMotte Company.

WARNING! This set contains chemicals that may be harmful if misused. Read cautions on individual containers carefully. Not to be used by children except under adult supervision.

TABLE OF CONTENTS

1. INTRODUCTION	5
2. GETTING STARTED	6
2.1 Description of Keypad Functions	7
2.2 Description of LCD Annunciators	7
2.3 Inserting & Removing the Rubber Boot/Stand	8
2.4 Inserting New Batteries	8
2.5 Battery Replacement	8
2.6 Connecting the Electrode and Temperature Sensor	9
2.7 Conditioning the pH Electrode	9
2.8 Switching the Meter On	10
3. CALIBRATION	10
3.1 pH Calibration	10
3.1.1 pH Calibration Procedure	11
3.1.2 Changing the pH Buffer Group	12
3.1.3 Resetting User Calibrated Values	13
3.2 Temperature Calibration	13
3.2.1 With Temperature Probe	13
3.2.2 Without Temperature Probe (no ATC)	14
4. MEASUREMENT	15
4.1 Taking Measurements	15
4.2 Holding a Reading	15
4.3 Releasing a Held Reading	15
5. ELECTRODE CARE AND MAINTENANCE	16
6. TROUBLESHOOTING	16
7. SPECIFICATIONS	17
8. REPLACEMENT PARTS AND ACCESSORIES	18
9. WARRANTY	18
10. RETURN OF ITEMS	19

1. INTRODUCTION

The pH 5 PLUS microprocessor-based handheld meter is economical and easy to use. It has a large custom LCD (Liquid Crystal Display) for clear and easy reading. The pH 5 PLUS measures pH and temperature (°C).

Meters include 4 alkaline “AAA” batteries, a rubber boot /stand, instruction manual, and warranty card. Please refer to Section 8 *Replacement Parts and Accessories* for information on additional accessories and calibration solutions.

2. GETTING STARTED

2.1 Description of Keypad Functions

The pH 5 PLUS has four keys on the splash-proof keypad: **ON/OFF**, **HOLD/ENTER**, **CAL** and **MODE/INC**.

ON/OFF	Powers meter on and off. Meter starts up in the mode that was last used.
MODE/INC	Increments values during temperature calibration mode.
CAL	Allows calibration for pH or Temperature, or to abort calibration and return to measure without confirming a value.
HOLD	Freezes the measured reading for easy viewing.
ENTER	Confirms calibration value.

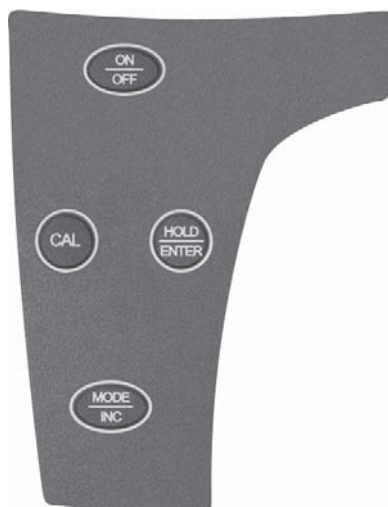

2.2 Description of LCD Annunciators

The large custom LCD consists of 3½-digit segments which uses annunciators for pH or °C (Temperature). Other annunciators include “**HO**” (when HOLD function is activated) and “**LO**” (low battery condition).



2.3 Inserting & Removing the Rubber Boot/Stand

1. To remove the meter from the rubber boot, push out the bottom edge of the meter until it is completely out of the boot. Ensure that the probe cables are not connected. See Figure 1.
2. To insert the meter into the rubber boot, slide in the top of the meter before pushing the bottom edge of the meter down to set it into position. Lift up the stand at the back of the meter for bench top applications. Figure 2.

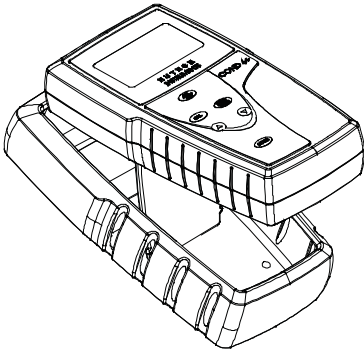

Figure 1

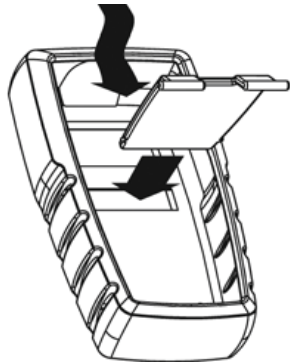
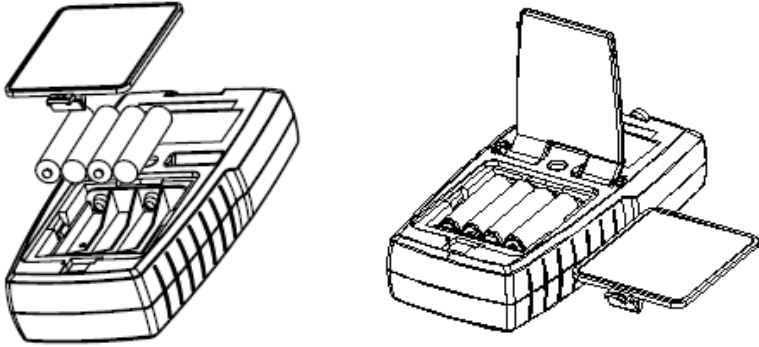

Figure 2

2.4 Inserting New Batteries

The battery compartment is found at the back of the instrument. To open the battery compartment, push the cover in the direction of the arrow and lift up. Note the polarity of the batteries before inserting them into position. After the batteries have been replaced, reposition the cover and press down until it locks.



2.5 Battery Replacement

The “LO” annunciator on the LCD alerts when battery power is running low.

Caution: Power off the meter before changing battery.



2.6 Connecting the Electrode and Temperature Sensor

To connect the probe to the meter, align the BNC connector slots with the posts of the meter socket and rotate the connector clockwise until it locks. Do not force the connector. To remove the probe, rotate the connector in a counter-clockwise direction until it unlocks, and slide the connector off the socket.

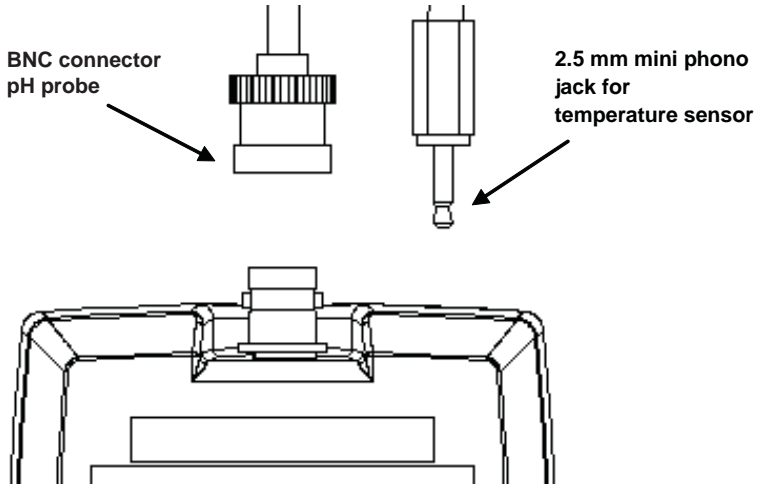

Insert the mini phono jack of the temperature sensor into the socket on the meter. Unplug the phono jack when not in use or when measuring pH without temperature compensation.

2.7 Conditioning the pH Electrode

For best results condition the pH probe before the first use, or if it has not been used for a long time, by soaking it in pH 4 buffer solution for at least 1 hour. Rinse before use.

2.8 Switching the Meter On

1. Press the **ON/OFF** key. All LCD segments will display momentarily as the meter performs a self-diagnostic test. The meter will display “- - -” if the meter has not been calibrated or if the meter has been reset.
2. Press the **MODE** key to choose the desired measurement mode.
3. If a temperature probe is not connected, either 25.0°C (factory default) or the last calibrated temperature value will be displayed. If a temperature probe is connected, the current measured temperature will be displayed.
4. “**Or**” (Over range) indicates the reading exceeds the maximum measurement range.

“**Ur**” (Under range) indicates the reading is under the minimum measurement range (see Section 7 Specifications).

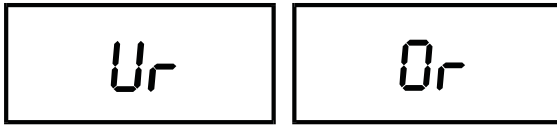

3. CALIBRATION

3.1 pH Calibration

The meter is capable of calibrating up to 3 pH values using USA or NIST (nSt) pH buffer standards or 2 pH values with Low Ionic (Pb) pH buffer standard. All new calibration values will automatically override existing data.

USA group	4.01, 7.00, 10.01
NIST group	4.01, 6.86, 9.18
Pb group	4.10, 6.97

For the best results perform at least a 2-point calibration at room temperature (25 °C) using standard buffers. Begin with pH 7.00 (USA group), pH 6.86 (NIST group) or pH 6.97 (Pb group).

For a 1-point calibration, the calibration should be performed with a pH buffer value closest to the expected sample value being measured.

The meter has automatic buffer recognition that identifies the correct pH buffer values during the calibration. The meter will accept calibration values that are within ± 1.0 pH units of the expected value, otherwise

the DISPLAY will flash “**Er1**” and the value will not be accepted. Press **CAL** to abort the calibration and return to the measurement mode.

Always use new pH buffer solutions for calibration. Do not reuse buffer solutions that may be contaminated and affect the calibration and accuracy of the measurements. Promptly seal containers and store solutions in a dark, dry, cool environment.

Before use, remove the plastic protective cap on the pH probe and condition the glass bulb by soaking it in tap water or pH buffer (preferably pH 4) for 1-2 hours. This will hydrate the glass bulb if the probe is too dry or if it has not been used recently. Always rinse the probe with clean water before and after each calibration or sample measurement to avoid cross-contamination. For details refer to Section 5 on Probe Care and Maintenance.

3.1.1 pH Calibration Procedure — Single Point

1. Pour a known pH buffer calibration standard solution, e.g. pH 7.00, into a clean, dry container. Turn on the meter and select the pH mode by pressing the **MODE** key.
2. Dip the pH probe and temperature probe into the solution. Stir gently and wait for the reading to stabilize (approximately 30 seconds depending on the probe condition).
3. Press **CAL** to enter the pH calibration mode. “**CA**” will be displayed momentarily before the display will flash the current un-calibrated reading.

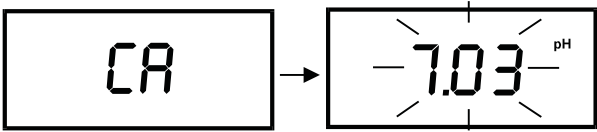

To abort or cancel the calibration without accepting the new value, press the **CAL** key. The meter will automatically revert to the pH measurement mode.

4. Allow the reading to stabilize. Press the **ENTER** key to confirm the calibration. “**CO**” will be displayed momentarily.

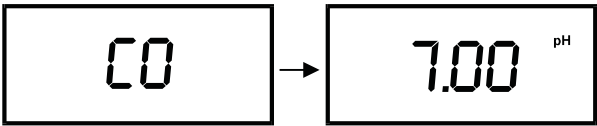

5. Press the **CAL** key to return to the measurement mode.

3.1.2 pH Calibration Procedure — Multiple Point

1. Pour a 7.0 pH buffer calibration standard solution into a clean, dry container. Turn on the meter and select the pH mode by pressing the **MODE** key.
2. Dip the pH probe and temperature probe into the solution. Stir gently and wait for the reading to stabilize (approximately 30 seconds depending on the probe condition).
3. Press **CAL** to enter the pH calibration mode. “CA” will be displayed momentarily before the display will flash the current un-calibrated reading.

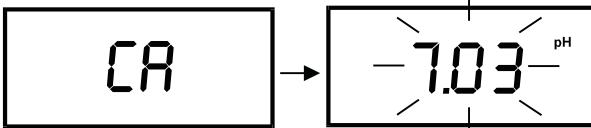

To abort or cancel the calibration without accepting the new value, press the **CAL** key. The meter will automatically revert to the pH measurement mode.

4. Allow the reading to stabilize. Press the **ENTER** key to confirm the calibration. “CO” will be displayed momentarily.

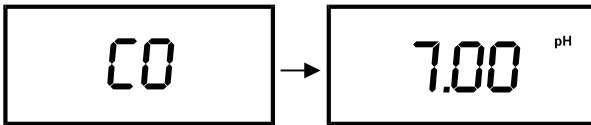

5. Pour a known pH buffer calibration standard solution, e.g. pH 4.00, into a clean, dry container.
6. Dip the pH probe and temperature probe into the solution. Stir gently and wait for the reading to stabilize (approximately 30 seconds depending on the probe condition).
7. Allow the reading to stabilize. Press the **ENTER** key to confirm the calibration. “CO” will be displayed momentarily.

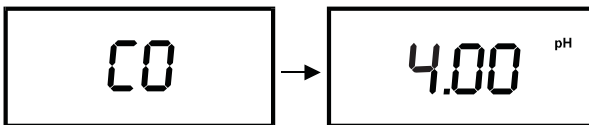

8. Press the **CAL** key to return to the measurement mode.

3.1.3 Changing the pH Buffer Group

The meter can be calibrated with pH standards of USA, NIST (nSt) or Low Ionic (Pb) pH buffer groups. The factory default is the USA buffer

group. To abort the buffer group selection, press **CAL** to revert to the pH measurement mode.

1. Press and hold **MODE** while switching the meter on using the **ON/OFF** key. The display will show “bUF” blinking.

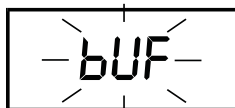

2. Press the **ENTER** key to begin the buffer group selection mode. Use the **MODE** key to toggle between USA, NIST or Pb as shown below.

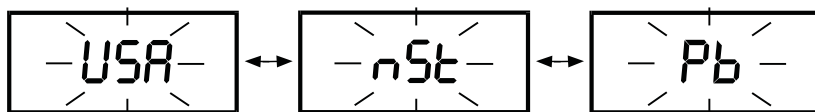

Press the **ENTER** key to confirm the selection. The meter will automatically revert to the pH measurement mode. The meter will save the selected group indefinitely until it is changed.

3.1.4 Resetting User Calibrated Values

The calibrated pH values can be reset to the factory default using the procedure below. The temperature offset will not be reset using this procedure. To abort the reset, press **CAL** to revert to the measurement mode.

1. Press and hold **CAL** while switching the meter on using the **ON/OFF** key. The DISPLAY will show “rSt” blinking.
2. Press the **ENTER** key to confirm. The meter will automatically clear all stored pH calibrations and revert to the measurement mode.

3.2 Temperature Calibration

3.2.1 With Temperature Probe

The temperature probe supplied with the meter is factory calibrated. Over time, the temperature calibration may drift and require recalibration. If the temperature probe is replaced the meter should be recalibrated.

1. Connect the temperature probe to the meter. Press the **MODE** key until the “°C” annunciator appears on the DISPLAY.
2. Compare the displayed value to a NIST certified thermometer or other thermometer known to be accurate. For the most accurate results, place both the probe and thermometer in a constant temperature bath.
3. Press the **CAL** key to enter the temperature calibration mode. The DISPLAY will show “CA” momentarily and the displayed reading will flash.

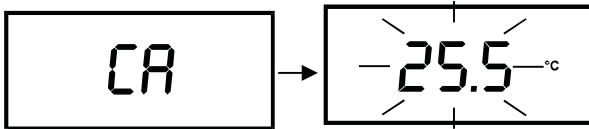

4. Press INC key until the display shows the desired temperature. The meter will allow an adjustable maximum value of ± 5 °C from the factory default.
5. To cancel or abort this operation, press the **CAL** key. To confirm the calibration, press the **ENTER** key. A new value will be stored in the meter non-volatile memory. The meter will display “CO” momentarily, and then revert to the measurement mode.

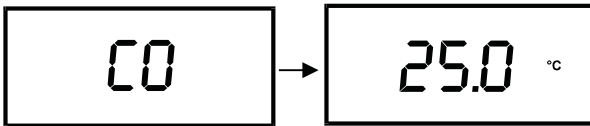

3.2.2 Without Temperature Probe (no ATC)

If a temperature probe is not used, the meter will compensate the pH response based on a temperature value that has been manually set or at the factory default of 25.0 °C.

1. Press the **MODE** key until “°C” shows on the DISPLAY.
2. Compare the displayed value to a NIST certified thermometer or thermometer that is known to be accurate (dipped into a constant temperature bath).
3. Press the **CAL** key to enter the temperature calibration mode. The DISPLAY will show “CA” momentarily and the displayed reading will flash. Note that the displayed value should be either 25.0 °C or the last set temperature value.

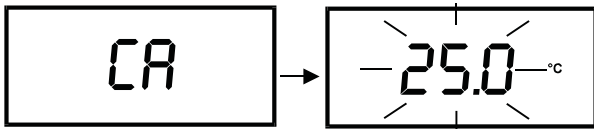

4. Press the **INC** key until the displays shows the desired temperature. The value can be set from 0 to 100 °C.
5. To cancel or abort this operation, press the **CAL** key. To confirm the calibration, press the **ENTER** key. A new value will be stored in the meter non-volatile memory. The DISPLAY will display “CO” momentarily, and the meter will revert to the measurement mode.

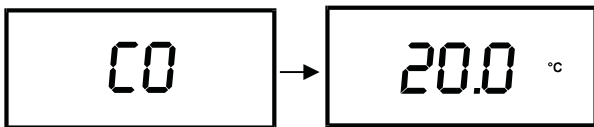

4. MEASUREMENT

4.1 Taking Measurements

1. Before measurement, rinse the pH probe and temperature probe with clean water to remove any impurities.
2. Power on the meter using the **ON/OFF** key. Press the **MODE** key to select the desired mode of operation (pH or Temperature).
3. Dip the probes in the aqueous test sample. Stir gently with the probes and wait for the reading to stabilize. Note the reading. Freeze the displayed if desired—for details refer to Section 4.2 Holding a Reading.
4. Rinse the probes with clean water before taking the next reading or storing the meter.

4.2 Holding a Reading

To freeze or hold the displayed reading, press the **HOLD** key once. The DISPLAY will display the “**HO**” annunciator to indicate the **HOLD** function is activated.

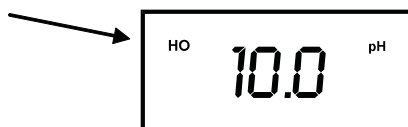

4.3 Releasing a Held Reading

Press the **HOLD** key once again to deactivate the **HOLD** function or to release the frozen reading. The meter will revert to the current measurement mode, and the “**HO**” annunciator will disappear from the DISPLAY.

5. ELECTRODE CARE AND MAINTENANCE

For best results, store the pH probe bulb wet. Store the pH glass bulb in pH probe storage solution. NEVER use deionized water for storage. Wash probes with clean water after each use.

pH probes are susceptible to contamination and dirt. Clean them as needed using mild detergent and warm water. Blot the probe gently with soft tissue paper to dry. Avoid excessive rubbing of the glass membrane and avoid touching it with the fingers. Recalibrate after cleaning.

6. TROUBLESHOOTING

Problem	Cause	Solution
No display	Batteries not in place.	a) Insert batteries. b) Re-insert batteries in correct polarity.
"LO" displays in the LCD	Low battery	Replace batteries.
Unstable reading	a) Electrode not deep enough in sample b) Dirty electrode. c) Broken electrode	a) Place electrode deeper in sample. b) Clean electrode and recalibrate. c) Replace electrode.
Not able to calibrate	a) Display freezes b) Faulty electrode c) Inaccurate buffer	a) Release reading by pressing HOLD. b) Replace electrode. c) Replace expired buffer solutions.
<i>ER1</i>	Buffer value out of tolerance	Use new calibration solution and recalibrate. Ensure correct pH buffer group was selected.
<i>ER3</i>	ISE slope not within the specified tolerance	Recalibrate
<i>ER5</i>	Upon exit of calibration mode, a 1-point calibration was attempted with a pH buffer other than 7.00 or 6.86	Repeat pH calibration using one or more points which include either 7.00 (USA) or 6.86 (NIST) standards.
<i>OE</i>	Over range: reading exceeds maximum value	Ensure that the value being measured is within the range of the selected mode. Confirm that electrode(s) are connected and working properly.
<i>UE</i>	Under range: reading exceeds minimum value	

7. SPECIFICATIONS

pH Range	0.00 to 14.00 pH
Resolution	0.01 pH
Accuracy	±0.01 pH
pH Slope Range	80 to 120%
No. of Calibration Pts	1 to 3 points (push-button)
Buffer Options	pH 4.01, 7.00, 10.01 (USA) pH 4.01, 6.86, 9.18 (NIST) pH 4.10, 6.97 (Pb)
Temperature Range	0.0 to 100.0 °C
Resolution	0.1 °C
Accuracy	±0.5 °C
Temperature Comp.	Automatic / Manual (0 to 100 °C)
Features	
Auto-Buffer Recognition	Yes
Hold Function	“HO”
Auto Shut Off	After 17 minutes
Low Battery Indication	“LO”
Display	Single Custom LCD
Operating Temperature	0 to 50 °C
Power Requirements	4 x “AAA” Alkaline Batteries
Battery Life	500 hours
Meter Dim./Weight	15.7 x 8.5 x 4.2 cm / 255 g

8. REPLACEMENT PARTS AND ACCESSORIES

Item Description	Code
pH Probe	1904
Temperature Probe	1909
AC Adapter, 110 mV	1726-110
AC Adapter, 220 mV	1754
Buffer, pH 4.01, 120 mL	2866-J
Buffer, pH 7.00, 120 mL	2881-J
Buffer, pH10.00, 120 mL	2896-J
Mini Buffer Tablets, pH 4.0, 50 tablets	3983A-H
Mini Buffer Tablets, pH 7.0, 50 tablets	3984A-H
Mini Buffer Tablets, pH 10.0, 50 tablets	3985A-H

9. WARRANTY

LaMotte Company warrants this instrument to be free of defects in parts and workmanship for 3 years from the date of shipment and the probe to be free of defects in parts and workmanship for 6 months from the date of shipment. If it should become necessary to return the instrument for service during or beyond the warranty period, contact our Technical Service Department at 1-800-344-3100 or tech@lamotte.com for a return authorization number or visit www.lamotte.com for troubleshooting help. The sender is responsible for shipping charges, freight, insurance and proper packaging to prevent damage in transit. This warranty does not apply to defects resulting from action of the user such as misuse, improper wiring, operation outside of specification, improper maintenance or repair, or unauthorized modification. LaMotte Company specifically disclaims any implied warranties or merchantability or fitness for a specific purpose and will not be liable for any direct, indirect, incidental or consequential damages. LaMotte Company's total liability is limited to repair or replacement of the product. The warranty set forth above is inclusive and no other warranty, whether written or oral, is expressed or implied.

10. RETURN OF ITEMS

Should it be necessary to return the meter for repair or servicing, pack the meter carefully in a suitable container with adequate packing material. A return authorization number must be obtained from LaMotte Company by calling 800-344-3100 (US only) or 410-778-3100, faxing 410-778-6394, or emailing tech@lamotte.com. Often a problem can be resolved over the phone or by email. If a return of the meter is necessary, attach a letter with the return authorization number, meter serial number, a brief description of problem and contact information including phone and FAX numbers to the shipping carton. This information will enable the service department to make the required



PO Box 329 • Chestertown • MD • 21620
800-344-3100 • 410-778-3100 • f 410-778-6394
www.lamotte.com